

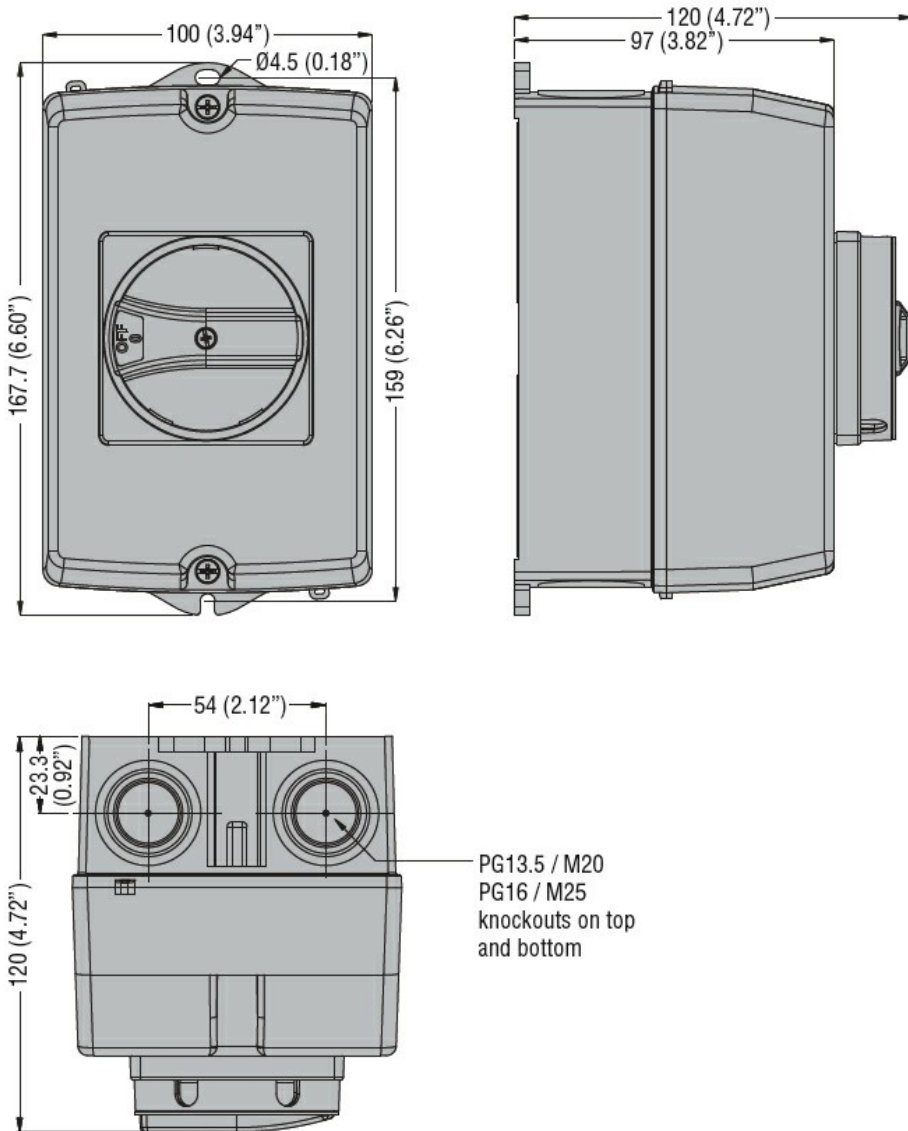

Product designation				Enclosed switch disconnecter
Product type designation				GAZ
Number of poles	Nr.			4
Operating voltage type				AC
Contact characteristics				
IEC Conventional free air thermal current I _{th}	A			16
Rated insulation voltage U _i IEC/EN	V			1000
Rated impulse withstand voltage U _{imp}	kV			8
Operating current I _e				
AC21A		400V	A	16
		500V	A	16
		690V	A	16
AC22A		400V	A	16
		500V	A	16
		690V	A	16
AC23A		400V	A	16
		500V	A	16
		690V	A	16
Power dissipation per pole max	W			0.2
Rated operational power AC23A		400V	kW	7.5
		690V	kW	11
Conditional short-circuit current (rms)	kA			10
Short-circuit protection with fuse	Class/A			gG16
Making capacity AC23A 400V	A			160
Breaking capacity AC23A 400V	A			128
Mechanical life	cycles			100000
Electrical life AC21A	cycles			100000
Mechanical features				
Operating position	normal allowable			Vertical plan Any
Terminals	type			Pillar
	width	mm	5.6	
	height	mm	6.5	
	screw			M4
	tool			Phillips 2
Tightening torque for terminals	min	Nm	1.8	
	max	Nm	2	

	min	lbin	16
	max	lbin	18
<hr/>			
Conductor section			
	IEC min	mm ²	0.75
	IEC max	mm ²	16
	AWG/kcmil min		18
	AWG/kcmil max		6
<hr/>			
UL technical data			
General purpose current rating		A	16
Operating voltage max		V	600
<hr/>			
Horsepower/FLA current single phase motor			
	120V	HP	1/16
	240V	HP	2/12
<hr/>			
Horsepower/FLA current three phase motor			
	200-208V	HP	5/17.5
	240V	HP	5/15,2
	480V	HP	10/14
	600V	HP	10/11
<hr/>			
Short circuit rating		kA rms	5
Short circuit rating with fuse		Class/A	RK5/30
<hr/>			
Ambient conditions			
Operating temperature			
	min	°C	-25
	max	°C	+55
<hr/>			
Storage temperature			
	min	°C	-40
	max	°C	+70
<hr/>			
Max altitude		m	3000
<hr/>			
Resistance & Protection			
Frontal IP degree			IP65
UL degree of protection			UL/CSA Type 4/4X
IP degree of protection			IP65
Pollution degree			3
<hr/>			
Dimensions			



Wiring diagrams

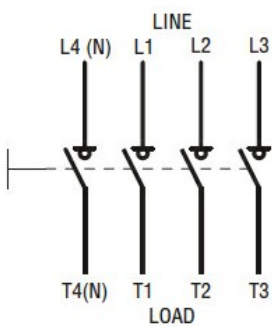

Certifications and compliance

Compliance

IEC/EN 60947-1
IEC/EN 60947-3

Certifications

cULus
EAC

ETIM classification

ETIM 8.0

EC000216 -
Switch
disconnecter